

# 2-INCH W X 24-INCH D X 24-INCH H LEGACY BRACKET

FRONT  
PROFILE

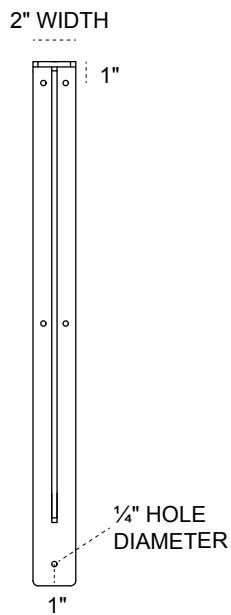

SIDE  
PROFILE

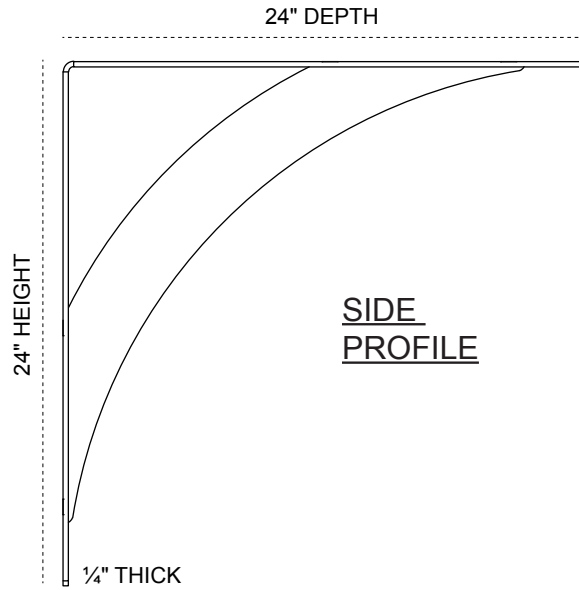

BACK

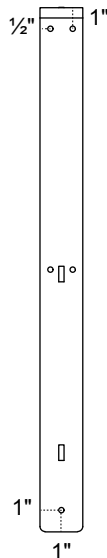

ISOMETRIC  
PROFILE

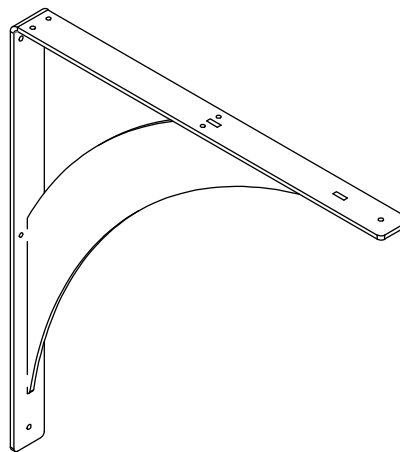

**HEAVY-DUTY 1/4" THICK**

**AVAILABLE IN:**  
STAINLESS STEEL  
ZINC PLATED STEEL  
POWDER COATED BLACK

**BKTM02X24X24LESS**  
**BKTM02X24X24LECRS**  
**BKTM02X24X24LEPBL**

P:866.607.0453 | F: 866.591.3143  
2300 W. Main St. | Clarksville, TX 75426  
sales@ekenamillwork.com | www.ekenamillwork.com



**EKENA**  
MILLWORK